



“PSX” update instruction manual

See.2.11

Compatible models: DESR-7500

DESR-5500

DESR-7700

DESR-5700

Customers using DESR-7500/5500
(Ver.2.06).....4
Customers using DESR-7700/5700
(Ver.2.10).....5

Please be sure to read it

Precautions when updating8
 “PSX” Certification 9
Precautions when handling CD-ROMs 10

to update

Updating over the network ... 12
Flow of network update 14
Updating (updating) with CD-ROM 17
Flow of CD-ROM update 19
Checking
if this unit has been updated.....
twenty two

Operation explanation of Ver.2.11

Dubbing video recorded on this unit to a
“Memory Stick” 24

About the file format of the video when
dubbing to a "Memory Stick" 24

Things to know before dubbing ..25

Step 1 Prepare the "Memory
Stick"28

Step 2 Select the video (title) to dub
.....33

Notes on "Dubbing to a "Memory Stick""
.....39

others

glossary...

Trademarks 43

Inquiries regarding

updates Back cover

Customers using DESR-7500/5500 (Ver.2.06)



video

Dubbing function to "Memory Stick"

TV programs recorded with "x-Omakase Maruroku", photo works created with "x-Pict Story", and video works shot with a digital video camera can now be dubbed to a "Memory Stick" and taken out. rice field.

Also, by dubbing to a "Memory Stick Duo" using the Memory Stick Duo Adapter (sold separately), you can play these works on a "PSP"* .

* "PSP" is a product of Sony Computer Entertainment Inc. "PSP" is a registered trademark of Sony Computer Entertainment Inc.

Continuous extension support for daily/weekly reservations

If you set the extension time manually when using the daily or weekly schedule, it will be extended in the same way each time (daily or weekly), not just the first time.



photo

x-Pict Story audition

function When selecting BGM in x-Pict Story, you can audition and check the BGM.

Customers using DESR-7700/5700 (Ver.2.10)



video

Improved dubbing time to "Memory Stick"

Approximately 10%* improvement in time required for conversion to Memory Stick video format .

* May vary depending on the recording mode and conditions of the video to be dubbed.

Auto power off function after dubbing to a "Memory Stick" You can now select to automatically turn off the power of this unit after dubbing to a "Memory Stick" is finished.

Please be sure to read it

Precautions when updating8

Precautions when handling CD-ROMs.....10

Thank you for purchasing the DESR-7500/5500/7700/5700. This instruction manual is for software update only for DESR-7500/5500/7700/5700 .

Please be sure to read the following notes before updating.

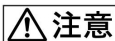

Do not use this CD-ROM for anything other than DESR-7500/5500/7700/5700.

Even if this CD-ROM is inserted into DESR-7000/5000 or DESR-7100/5100, it will not work.

Precautions when updating

- Be sure to read " Updating " (page 11) before updating.
- Make sure that there is no scheduled recording within 1-2 hours before the update starts .
- Recording does not start even if scheduled recording start time comes during update.
- Do not update while the unit is recording or optimizing, as the software will not be updated properly.

About "PSX" certification

"PSX" uses "DNAS" (Dynamic Network Authentication System), an authentication system unique to Sony Computer Entertainment Inc. that enables copyright and security protection. The law prohibits the transfer, delivery, display, export, import, or transmission of this system's deactivation device or program. Please note that content compatible with "DNAS" cannot be used on other "PSX" or "PlayStation 2" systems.

Precautions when handling CD-ROMs

- **Hold** the CD-ROM so that you do not touch the playing surface. please.



- Do not place in direct sunlight, high temperature or high humidity.
- Store in a case. • Fingerprints and dirt on the CD-ROM can cause read errors . Please keep it clean at all times.
- Gently wipe the CD-ROM from the center outwards with a soft cloth. If it is very dirty, wipe it with a soft cloth slightly moistened with water, and then wipe off the moisture with a dry cloth.
- Benzene, record cleaners, anti-static agents, etc. Do not use it as it may damage the CD-ROM.





to update

Updating (updating) over the network	12
Flow of network update.....	14
Updating (updating) with a CD-ROM	17
Flow of CD-ROM update.....	19
Checking if the unit has been updated.....	22

There are two methods for updating this unit: network and CD-ROM (page 17).

Update via network

You can update without using a CD-ROM by connecting this machine to the network . Be sure to complete the network settings before performing the network update. For network settings, refer to “ Network Connection and Settings” in the instruction manual that comes with the “PSX” (page 131 for DESR-7500/5500, page 137 for DESR-7700/5700).) .

Step1 Select (Network Update) from (Settings) in the home menu with  and press  . The network update start screen is displayed.

Step2  Press.
Network update work will start.

Refer to “Flow of network update” (page 14)
and follow the instructions on the screen.

If an error message is displayed during the update, check the network connection and settings according to the message displayed on the screen, and start over from Step 1 . If the error message still appears , please contact the “PSX” Upgrade Desk listed on the back cover .

Recovery processing may be performed depending on the content of the error that occurred during the update. In such a case, wait for the recovery process to complete, and then start over from Step 1 .

Flow of network update

1 Software check



2 Display of software license agreement

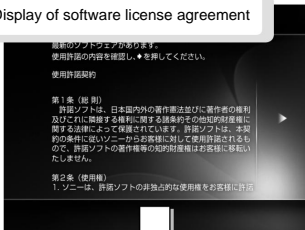

3 Confirmation of software license agreement



4 Update confirmation screen



5 "DNAS" certification



6Software download



9Backup screen



7Restart confirmation screen



10Installation screen



8 Automatically reboot

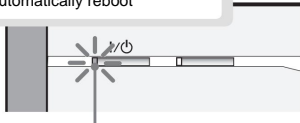

Power light flashes green

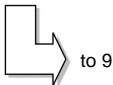

11Restart confirmation screen

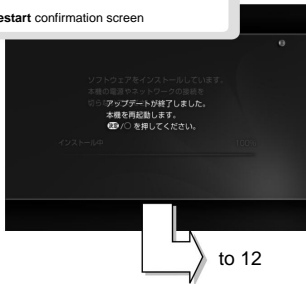

12 Automatically reboot

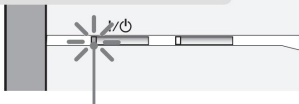

After blinking in green, it lights up in red, and then lights up in green in about 1 second .



Displaying 13 TV programs



14 update finished

Check that the version of this unit has been updated to “2.11” by referring to “Checking if this unit has been updated” (page 22) .

Updating (updating) with CD-ROM

Those who cannot connect to the network using "PSX"
can update using the update CD-ROM.

The update CD-ROM will be distributed free of charge . For more information, please visit the website listed on the back cover or contact the "PSX" Upgrade Desk.

Step1 Insert the update CD-ROM into this unit .

Step2 Press \triangle to select (Disk) from (Game) in the home menu and press \circ .



Continued on next page

CD-ROM update work will start.

Refer to “CD-ROM update flow” (page 19) and follow the on-screen instructions.

If an error message is displayed during the update, start over from Step 1. If the error message still appears , please contact the “PSX” Upgrade Desk listed on the back cover. Recovery processing may be performed depending on the content of the error that occurred during the update. In such a case, wait for the recovery process to complete, and then start over from Step 1 .

Flow of CD-ROM update

1 Update start screen

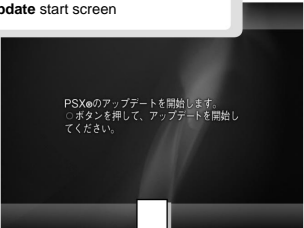

PSX®のアップデートを開始します。
○ボタンを押して、アップデートを開始してください。

2 Display of software license agreement



使用許諾契約
使用許諾契約を確認したら○を押して
次の画面に進んでください。

ソフトウェア使用許諾契約書

本契約は、お客様(以下お客様とします)とソニー株式会社(以下ソニーとします)との間での下記のソフトウェア(以下許諾ソフトとします)の使用権の許諾に関する条件を定めるものです。

許諾ソフト|PSX® upgrade software

to 3

3 Confirm that you agree to the software license



使用許諾に同意しますか。
↑で選んで○を押してください。

同意しない
同意する

4 Start confirmation screen

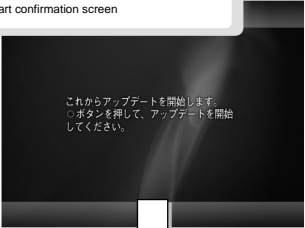

これからアップデートを開始します。
○ボタンを押して、アップデートを開始してください。

5 Update preparation screen

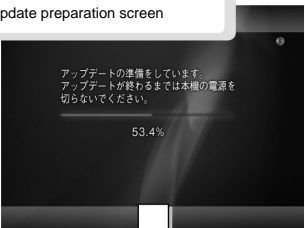

アップデートの準備をしています。
アップデートが終わるまでは本機の電源を
切らないでください。

53.4%

to 6

6 Installation confirmation screen

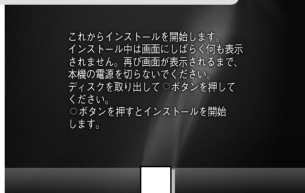

7 Eject the CD-ROM

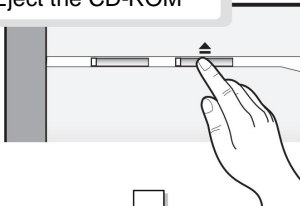

8 Press OK

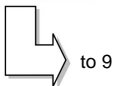

to 9

9 Reboot automatically

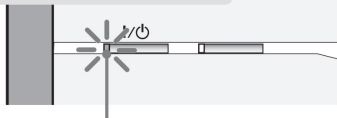

Power light stays green



10 Backup screen



11 Installation screen



to 12

12 Restart confirmation screen

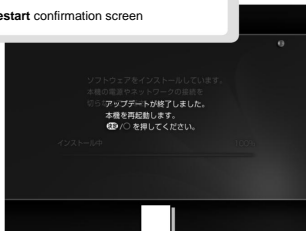

13 Automatically reboot

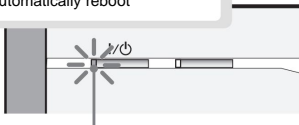

After blinking in green, it lights up in red, and then lights up in green in about 1 second .

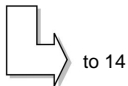

Display of 14 TV programs



15 update finished

Check that the version of this unit has been updated to "2.11" by referring to "Checking if this unit has been updated" (page 22) .

Check if the unit has been updated

Step1 Press `ÿÿÿÿ` to select (main unit settings) from (settings) in the home menu .

Step2 Select [System information] with `ÿÿ` and press `.` Make sure that the "Version" column is "2.11" .



Operation explanation of Ver.2.11

Dubbing video recorded on this unit to a
“Memory Stick”24

Dubbing video recorded on this unit to a “Memory Stick”

File format of video when dubbing to “Memory Stick”

You can dub video recorded on this unit to a “Memory Stick” and view it on a terminal that supports the video format of this unit.

You can dub even while recording. You can also schedule recording even during dubbing.

This unit records video on a “Memory Stick” or “Memory Stick Duo” as MPEG-4 files in MP4 format conforming to the Memory Stick Video Format* .

Videos recorded on a “Memory Stick Duo” using this unit can be played back on a “PSP” (PSP-1000). MP4 format video recorded on a “Memory Stick” cannot be played back on this unit.

* Memory Stick Video Format is a video format established for “Memory Stick” for recording TV broadcasts and personal content shot with a video camera.

Things to know before
dubbing

About the video length that can be recorded on a "Memory Stick"

The length of video that can be recorded on a "Memory Stick" varies depending on the video recording mode.

Recording mode	Recording time* ¹	audio* ²
Image quality	about 30 minutes	stereo
768kbps high 384kbps low	about 55 minutes	stereo

*) Dubbing to a "Memory Stick" takes about 5 times the recording time in the recording mode "768 kbps" and about 4 times the recording time in the "384 kbps" mode.

Also, dubbing time varies depending on conditions such as the recording mode recorded on the hard disk with this unit and the recorded video.

*) Memory Stick Video Format is a highly compressed video format. The quality of the dubbed video may differ from the original video.

¹ This is the estimated recording time for one 256MB "Memory Stick".

² Audio is recorded in AAC.

Dubbing time to a "Memory Stick" This unit can dub up to 2 hours of video in total playback time.

Videos that exceed 2 hours should be edited so that the total playback time is within 2 hours before dubbing.

When dubbing images to a “Memory Stick Duo”

Be sure to attach the Memory Stick Duo adapter to the “Memory Stick Duo” before inserting it into your camcorder. Insert it into the MEMORY STICK slot.

メモリースティック
デュオ アダプター (別売り)

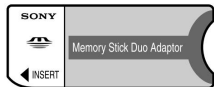

“メモリースティック
デュオ” (別売り)



◀ マークの方向に差し込む

please note

- When using a “Memory Stick Duo” with your camcorder, be sure to insert the “Memory Stick Duo” into the Memory Stick Duo Adapter.
- If you insert the Memory Stick Duo without the adapter attached, the “Memory Stick Duo” may not be able to be ejected.

Types of “Memory Stick” that can be used with this unit

Types of “Memory Stick” supported by this unit	
“Memory Stick”	•
“Memory Stick Duo”	ÿ (adapter required)
“Memory Stick (MagicGate)”	•
“Memory Stick Duo (MagicGate)”	ÿ (adapter required)
“MagicGate Memory Stick”	•
“MagicGate Memory Stick Duo”	ÿ (adapter required)
“Memory Stick PRO”	•
“Memory Stick PRO Duo”	ÿ (adapter required)

- High-speed data transfer using a parallel interface is not supported.
- Data recording/playback that requires the MagicGate function cannot be performed.
I can't

Operation has been confirmed with this unit using a Sony “Memory Stick” of up to 1 GB. However, we do not guarantee operation with all “Memory Sticks”. (As of May 2005)

Step 1 Prepare
the "Memory Stick"

Step 1 In

the "Memory Stick" into the unit.

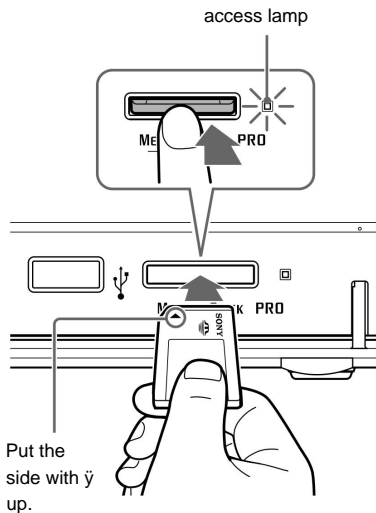

Step2



Select (HDD)MS dubbing)

and press .



After this, do not remove the “Memory Stick” until dubbing is complete.

Continued on next page

Step3

 Press.

Check the "Memory Stick".



Step 4 Select the recording method with  and

press . If you select “Append”, the video will be dubbed without erasing the data recorded on the “Memory Stick”.

If you select “Delete all videos”, all videos recorded in the MP_ROOT folder of the “Memory Stick ” will be deleted before dubbing. For details on the hierarchical structure of folders and files recorded on a “Memory Stick,” see “MP4 file storage locations ” (page 40).

Select “Format” to format the “Memory Stick” before dubbing. Please note that formatting a “Memory Stick” will erase all data recorded on the “Memory Stick”.

Continued on next page 

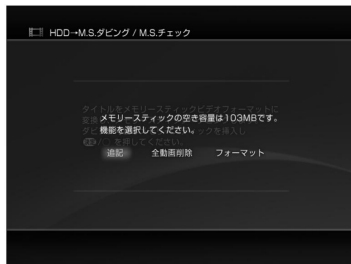

Deleting images recorded on a “Memory Stick”

With this unit, it is not possible to erase only part of the dubbed video. If you want to delete the videos, you can delete all the videos and thumbnails recorded on the “Memory Stick” by executing “Delete all videos”.

Step 2 Select the video (title)
to dub

Step5 Pre

ÿÿ to select the videos in the order you want to dub
and press .

決定

They will be dubbed in the selected order.

Check the free space on the "Memory Stick" to be dubbed
from the "Memory Stick" image displayed on the right
side of the screen while selecting the video.



Images that are being recorded and images that can be
recorded only once cannot be dubbed to a "Memory
Stick".

Continued on next page

If you want to change the order

1 Select the selected image again with  and press .

The selection is cleared.

2 **Reselect** the videos in the order you want to dub them  and press .

Step 6



Press.

An option screen for changing the recording mode and sound appears. The recording mode is automatically set to 768kbps and the main audio is automatically set.

If there is no need to change , proceed to Step 9.

Step7 Select the option you want to change with **↑** and **↓** and press **Enter**.



Step8 Select the setting with **↑** and **↓** and press **Enter**.



Continued on next page

When dubbing a video containing both main and sub audio

If the video before dubbing contains both main and secondary audio , you can select which audio to record as shown in the screen below. The default setting is to record the main sound.



If the total size of the selected images exceeds the free space on the “Memory Stick”

By changing the video recording mode and reducing the data size, you can dub according to the free space of the “Memory Stick”.

Step9 A changing the options, press \checkmark .

Step10 C the order to write the video  and press \checkmark .



Step11 Use **ŸŸ** to select whether to turn off the power after dubbing is complete, then press **Ÿ**.

Dubbing starts automatically.

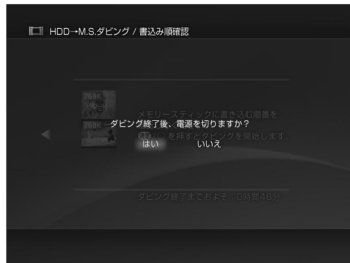

If you select "Yes", the power will automatically turn off after dubbing is finished.

Notes on “Dubbing to a “Memory Stick””

- Dubbing is not possible during optimization.
- You cannot dub images that are being recorded.
- Only files conforming to the Memory Stick Video format can be deleted with [Delete All Videos].
- Videos with a total playback time of more than 2 hours after editing cannot be dubbed.
- If the total playback time of the selected videos exceeds 2 hours, cannot be used for dubbing.
- You cannot select and dub 16 or more videos.
plug.
- A “Memory Stick” formatted by a device other than this unit may not work properly. We recommend that you format the “Memory Stick” on this unit before dubbing.
- “Record only once” video on a “Memory Stick”
You cannot dive.

About MP4 file storage location

As shown in the diagram below, MP4 files dubbed to a "Memory Stick" with this unit are saved in the third layer from the root of the "Memory Stick".

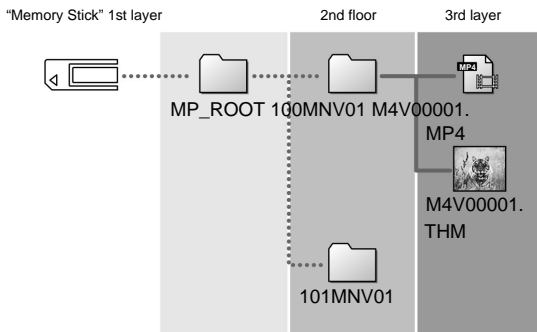

- A folder called "MP_ROOT" is always created in the first layer, and a folder for saving video is created in this folder.
- In the folder for saving videos on the second layer, Video files in MP4 format and thumbnail files to be displayed on playback devices are saved. Video files have the extension "MP4" and thumbnails have the extension "THM" .

others

glossary ...

Trademarks.....43

Inquiries regarding

updates.....Back cover

glossary

memory stick video format

This is a video format for easy enjoyment of TV broadcasts and personal content shot with a video camera.

MP4 [MP4]

MPEG-4 file format. This unit's HDD 7 MS dubbing uses the Memory Stick video format conforming to MP4 .

Trademarks

 "PSX", "PlayStation" and "PSP"

Registered Sony Computer Entertainment Inc.

registered trademark. In addition, "DNAS" is a trademark of the company.

"SONY" is a registered trademark of Sony Corporation.

"Memory Stick" ("Memory Stick") and "Memory Stick Duo" ("Memory Stick Duo") are Sony

It is a trademark of the company.

Inquiries about updates

“PSX” upgrade desk Phone

number: 0120-252-645 (toll-free)

Reception hours: Monday-Friday 9 :00-20: 00 Saturdays, Sundays, and holidays 9: 00-17: 00

You can also find information about updates on the
“PSX” website.

<http://www.psx.sony.co.jp/>



This manual uses 100% recycled recycled paper for the cover,
100% recycled chlorine -free bleached paper, and VOC (volatile
organic compound)-free vegetable oil ink for the text.